

Die folgenden Normenabbildungen dienen zur allgemeinen Orientierung. Sie sind besonders dann nützlich, wenn dem Anwender die Normnummern der für ihn interessanten Normen nicht geläufig sind. Die zeilenweise orientierte Reihenfolge entspricht der Strukturgliederung der Normenübersicht. Lediglich die Gruppe der Halbzeuge sind ausgenommen, weil ihre Darstellung kaum mehr informativen Charakter besitzt als ihre Textbeschreibung.

Darstellungsformen

Alle Normenabbildungen enthalten neben der Normnummer nur eine, möglichst repräsentative Darstellung in einem Darstellungsgrad, einer Ansicht, einer Ansichtsvariante, einem Einbauzustand und einem Satz von Funktionsmerkmalen. D.h. die eigentliche Vielfalt jeder Norm kann hier nicht zum Ausdruck gebracht werden. Die folgende Abbildung zeigt dies am Beispiel des Stellringes DIN 705:

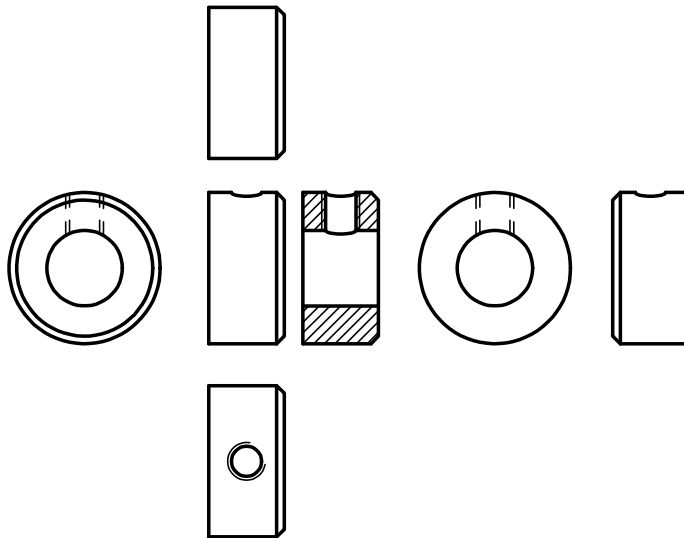

Formenvielfalt



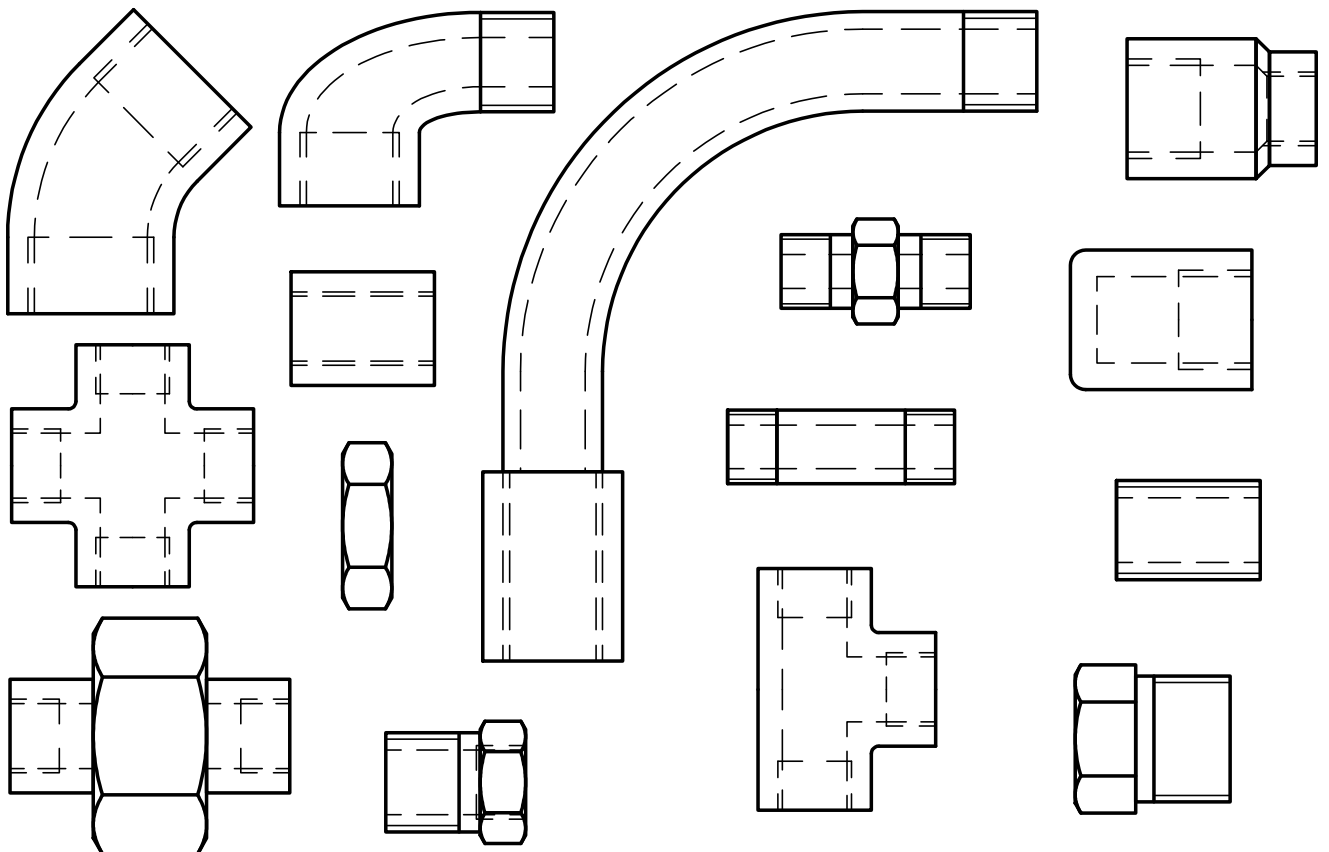

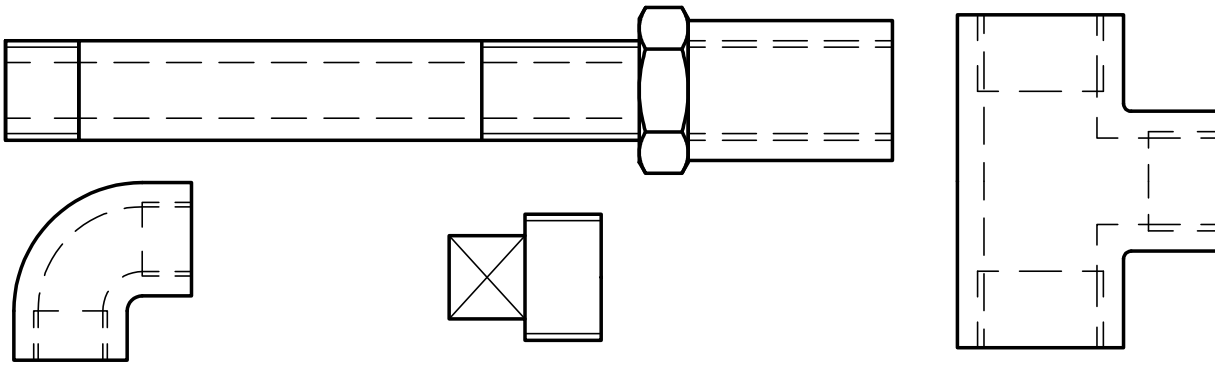



Darüber hinaus können nicht nur bis zu 6000 Merkmaldatensätze innerhalb einer Norm zur Verfügung stehen, sondern auch diverse geometrische Formen existieren. Ein gutes Beispiel hierfür ist die Norm DIN EN 10241:

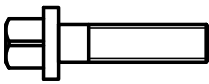
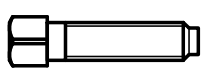
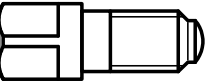
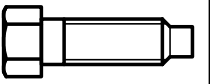
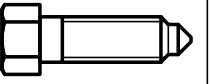
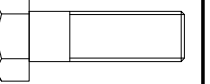
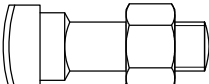
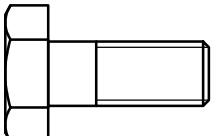
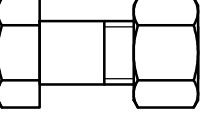
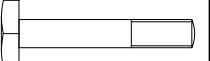
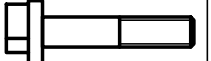
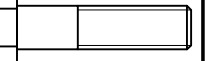
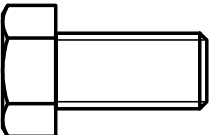
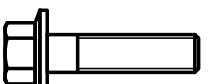
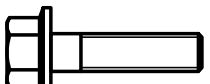
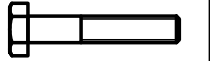
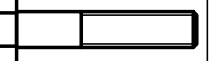
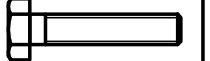
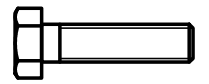
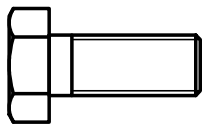
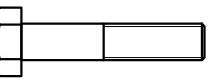
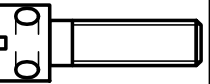
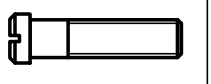
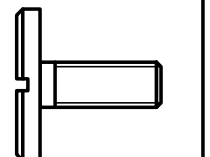
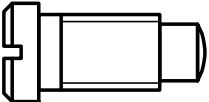
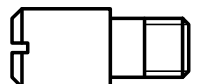
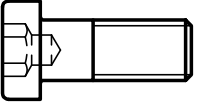
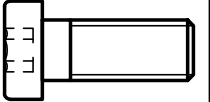
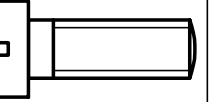
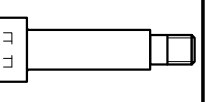
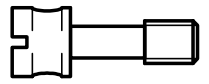

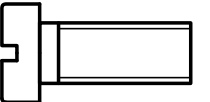

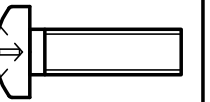
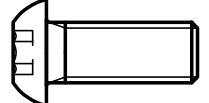
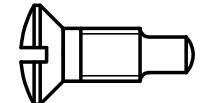
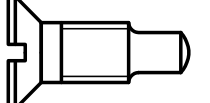
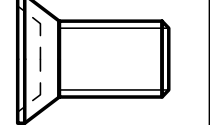

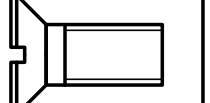
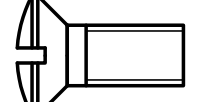
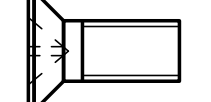
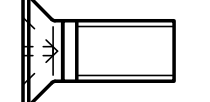
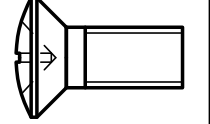
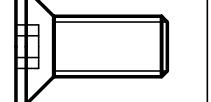
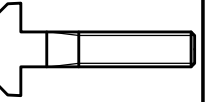
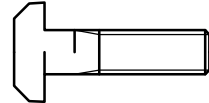
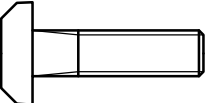

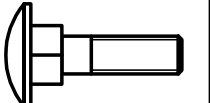
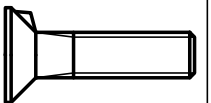
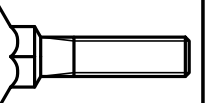

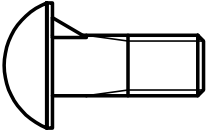
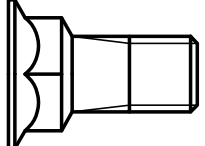
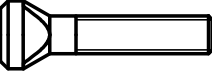
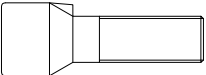
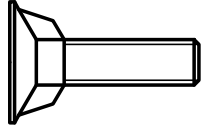
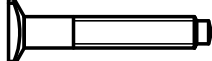
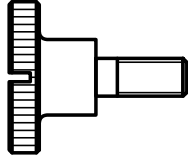
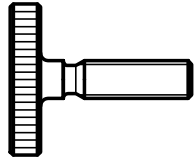

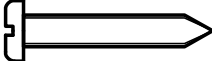
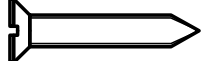
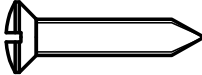



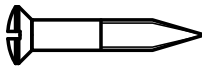
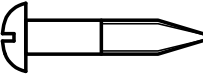
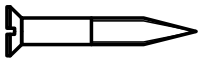
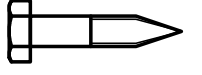
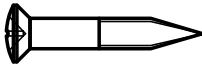
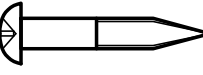
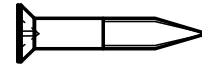
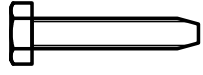

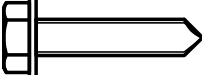

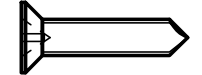
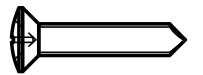
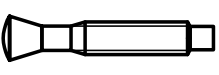
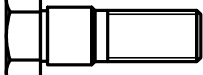
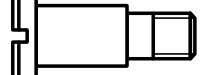
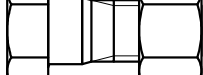
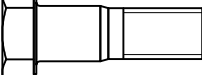
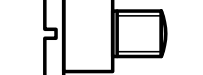
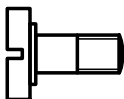
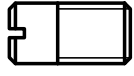
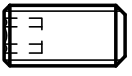
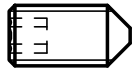
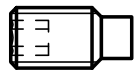
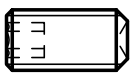
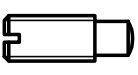

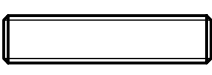
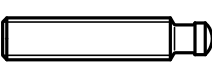

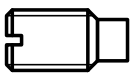

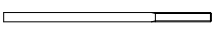
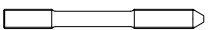

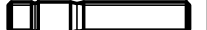







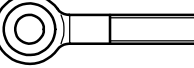
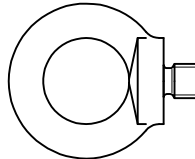
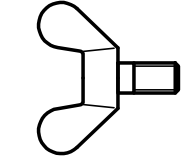
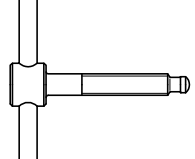
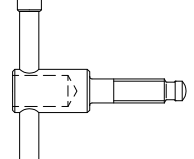
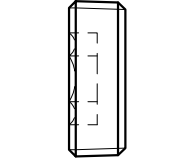
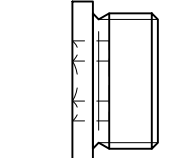
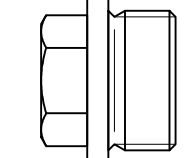
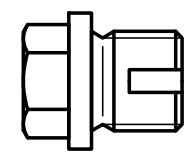
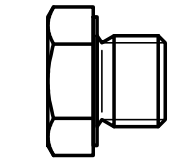
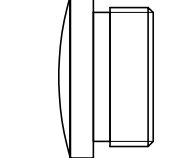
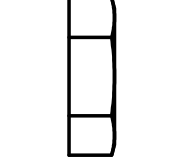
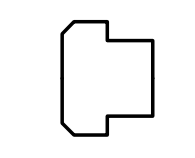
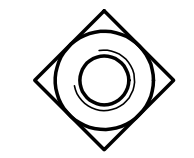
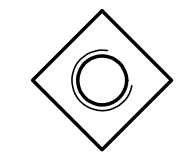
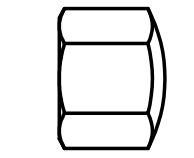
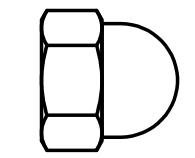
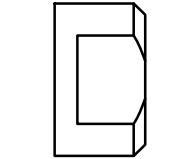
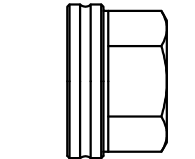
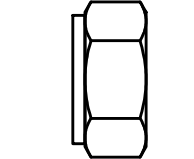
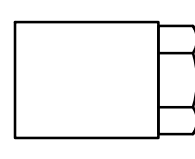
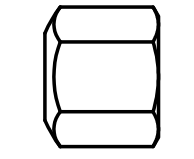
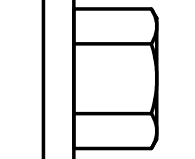
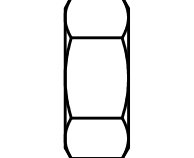
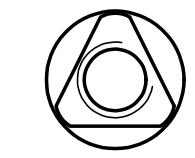
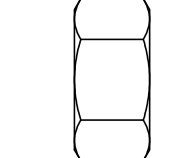
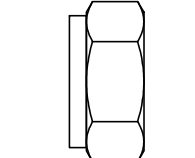
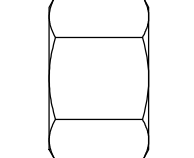
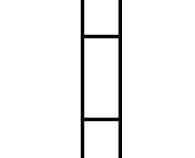
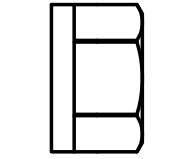
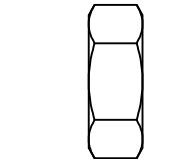
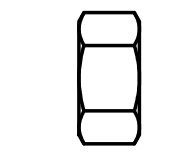
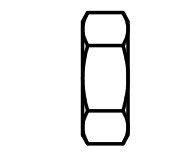
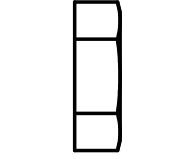
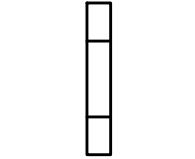
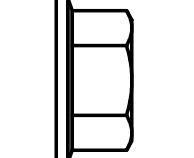
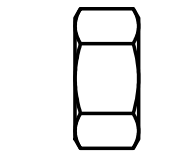
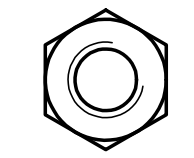
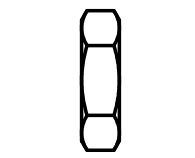
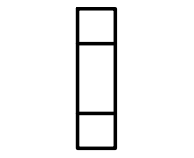
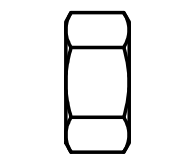
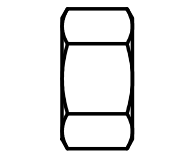
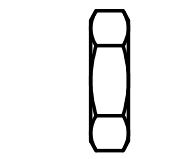
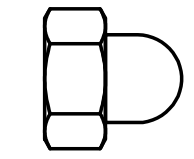
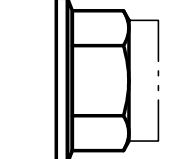
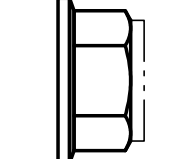
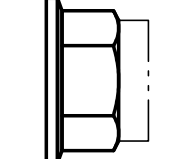

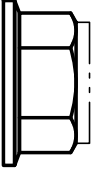
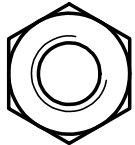
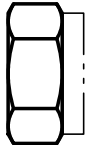

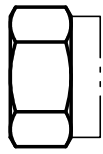
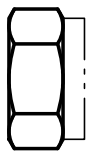
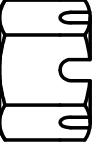
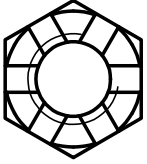

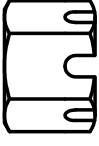

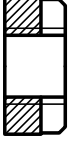

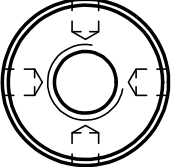



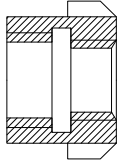

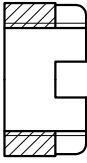
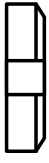
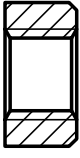
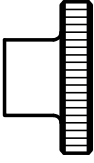
Sie schließt im Bereich Rohrleitungsformstücke und Stahlittings Winkel, Rohrbögen, Federn, T-Stücke, Kreuze, Muffen, reduzierte Muffen, Doppelnippel, Reduzierstücke, Stopfen, Gegenmuttern, Kappen, Langgewinde, Rohrdoppelnippel, Gewindenippel, Verschraubungen u.a. ein. Jede dieser Formen besitzt wiederum zahlreiche Merkmaldatensätze (Größen), Ansichten usw. In dieser Übersicht von Normenabbildungen wird die Norm DIN EN 10241 aber nur durch eine einzige Darstellung repräsentiert.

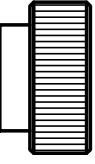
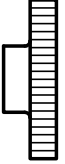
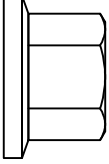
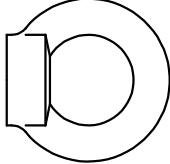
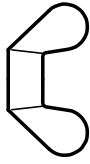
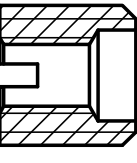
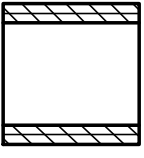
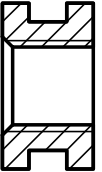
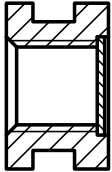
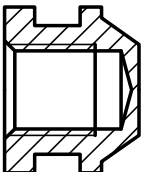
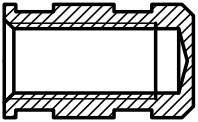

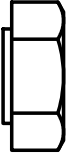

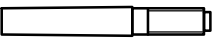
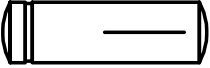

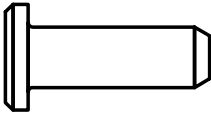

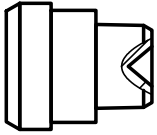
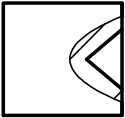
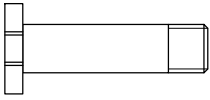
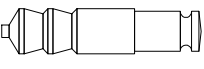
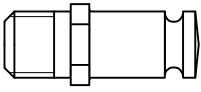
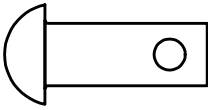
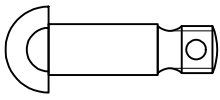

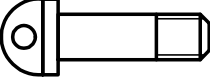



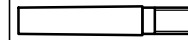
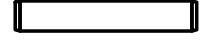

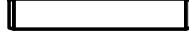

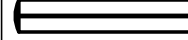
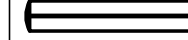
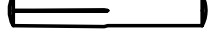
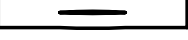
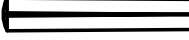

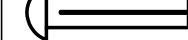







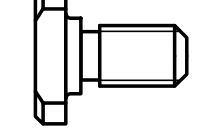
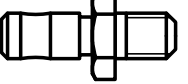



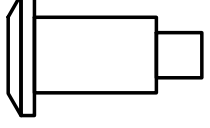

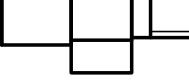
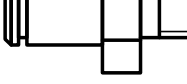
Die Normenabbildungen sind daher nur als ganz grobe Anhaltspunkte zu betrachten.

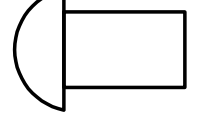
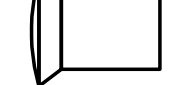

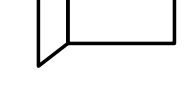
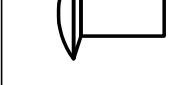
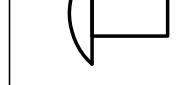
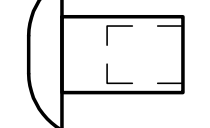
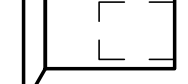



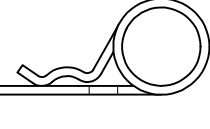
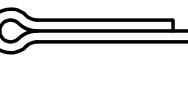
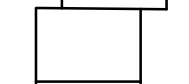

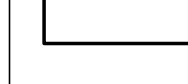

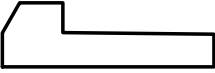
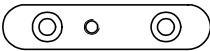
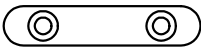

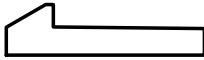

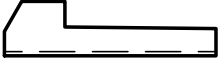
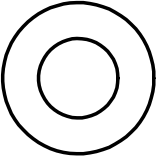
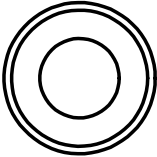

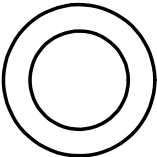

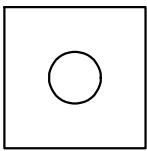
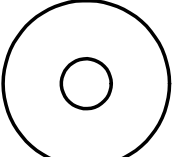
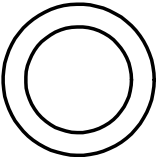
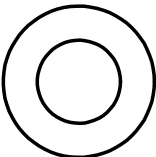

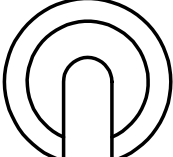

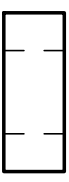
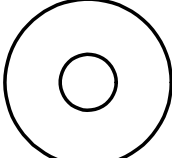
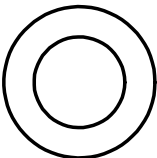
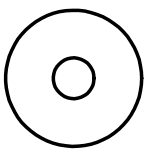
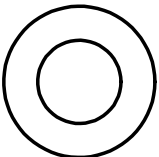

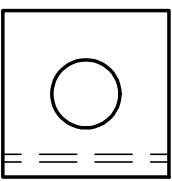



| | | | | | |
|---|---|---|--|---|---|
|  |  |  |  |  |  |
| DIN 478 | DIN 479 | DIN 480 | DIN 561 | DIN 564 | DIN 931-2 |
|  |  |  |  |  |  |
| DIN 5903-2 | DIN 6914 | DIN 7990 | DIN 21346 | DIN 22424 | DIN 70613 |
|  |  |  |  |  |  |
| DIN 70614 | DIN EN 1662 | DIN EN 1665 | DIN EN 24014 | DIN EN 24016 | DIN EN 24017 |
|  |  |  |  |  |  |
| DIN EN 24018 | DIN EN 28676 | DIN EN 28765 | DIN 404 | DIN 920 | DIN 921 |
|  |  |  |  |  |  |
| DIN 922 | DIN 927 | DIN 6912 | DIN 7984 | DIN 8243 | DIN 9841 |
|  |  |  |  |  |  |
| DIN 43854 | DIN 58450 | DIN EN ISO 1207 | DIN EN ISO 1580 | DIN EN ISO 4762 | DIN EN ISO 7045 |
|  |  |  |  |  |  |
| DIN EN ISO 7380 | DIN 924 | DIN 925 | DIN 7969 | DIN 8245 | DIN EN ISO 2009 |
|  |  |  |  |  |  |
| DIN EN ISO 2010 | DIN EN ISO 7046-1 | DIN EN ISO 7046-2 | DIN EN ISO 7047 | DIN EN ISO 10642 | DIN 186 |
|  |  |  |  |  |  |
| DIN 188 | DIN 261 | DIN 7992 | DIN 603 | DIN 604 | DIN 605 |

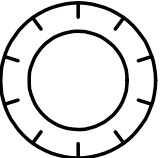
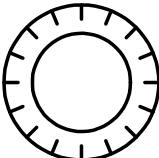

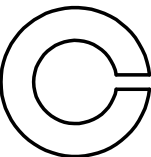

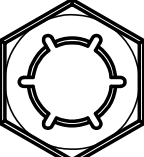

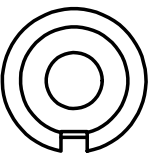
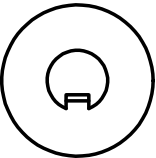

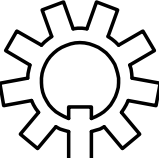
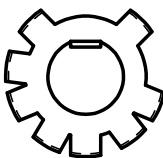

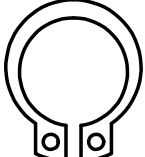
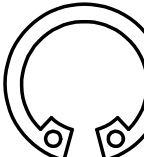
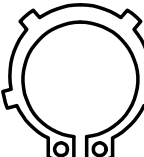
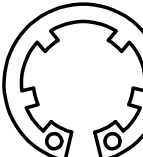
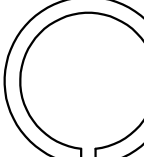
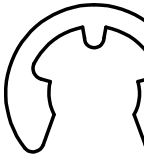
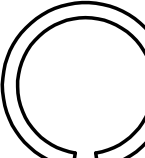
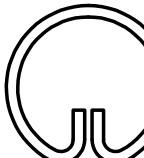

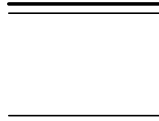
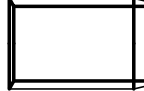

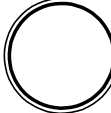



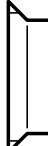
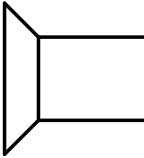
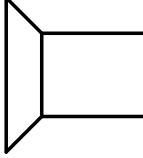
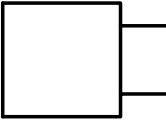
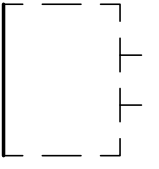
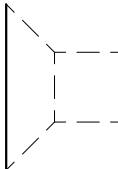
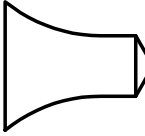
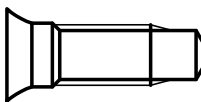
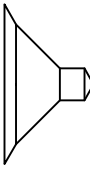
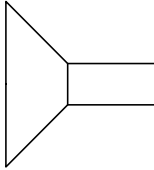

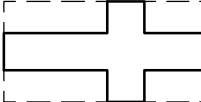
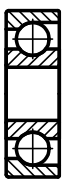
| | | | | | |
|---|---|---|---|---|---|
|  |  |  |  |  |  |
| DIN 607 | DIN 608 | DIN 787 | DIN 792 | DIN 25195 | DIN 58520-1 |
|  |  |  |  |  |  |
| DIN 464 | DIN 653 | DIN 6928 | DIN ISO 1479 | DIN ISO 1481 | DIN ISO 1482 |
|  |  |  |  |  |  |
| DIN ISO 1483 | DIN ISO 7049 | DIN ISO 7050 | DIN ISO 7051 | DIN 95 | DIN 96 |
|  |  |  |  |  |  |
| DIN 97 | DIN 571 | DIN 7995 | DIN 7996 | DIN 7997 | DIN 7500-1 |
|  |  |  |  |  |  |
| DIN 7513 | DIN 7516 | DIN EN ISO 15480 | DIN EN ISO 15481 | DIN EN ISO 15482 | DIN EN ISO 15483 |
|  |  |  |  |  |  |
| DIN 58520-2 | DIN 609 | DIN 923 | DIN 7968 | DIN 7999 | DIN 58326 |
|  |  |  |  |  |  |
| DIN 58328 | DIN 427 | DIN 913 | DIN 914 | DIN 915 | DIN 916 |
|  |  |  |  |  |  |
| DIN 926 | DIN 976-1 | DIN 976-2 | DIN 6332 | DIN EN 24766 | DIN EN 27434 |
|  |  |  |  |  |  |
| DIN EN 27435 | DIN EN 27436 | DIN 525 | DIN 797 | DIN 835 | DIN 938 |

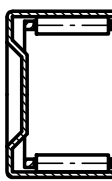
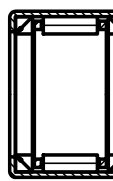
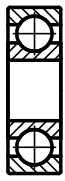
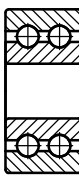
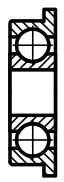
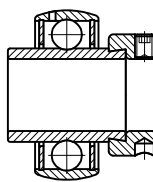
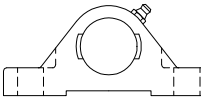
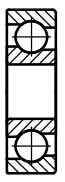

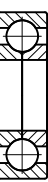
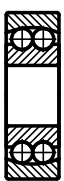
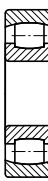

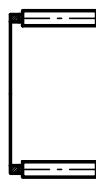
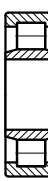





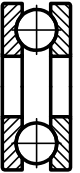
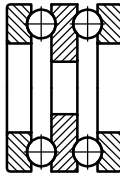

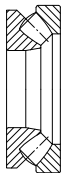

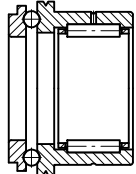
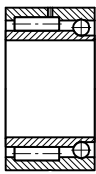
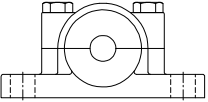
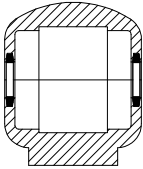
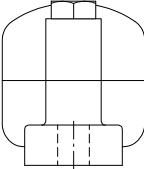

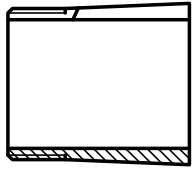
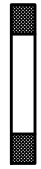
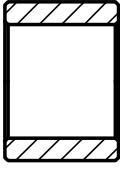
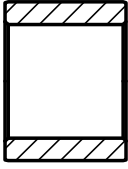
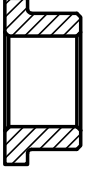
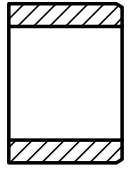
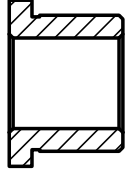
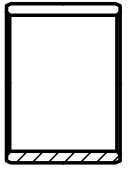
| | | | | | |
|---|---|---|--|---|---|
|  |  |  |  |  |  |
| DIN 939 | DIN 940 | DIN 2509 | DIN 2510-3 | DIN 2510-4 | DIN 529 |
|  |  |  |  |  | |
| DIN 444 | DIN 580 | DIN 316 | DIN 6304 | DIN 6306 | |
|  |  |  |  |  |  |
| DIN 906 | DIN 908 | DIN 910 | DIN 5586 | DIN 7604 | DIN 86129 |
|  |  |  |  |  |  |
| DIN 431 | DIN 508 | DIN 557 | DIN 562 | DIN 917 | DIN 1587 |
|  |  |  |  |  |  |
| DIN 2082-1 | DIN 2082-2 | DIN 2510-5 | DIN 2510-6 | DIN 6330 | DIN 6331 |
|  |  |  |  |  |  |
| DIN 6915 | DIN 22425 | DIN 30386 | DIN 30387 | DIN 30389 | DIN 44879 |
|  |  |  |  |  |  |
| DIN 55027 | DIN 64032 | DIN 70615 | DIN 70616 | DIN 80705 | DIN 89280-2 |
|  |  |  |  |  |  |
| DIN EN 1661 | DIN EN 24032 | DIN EN 24034 | DIN EN 24035 | DIN EN 24036 | DIN EN 28673 |
|  |  |  |  |  |  |
| DIN EN 28674 | DIN EN 28675 | DIN 986 | DIN EN 1663 | DIN EN 1664 | DIN EN 1666 |

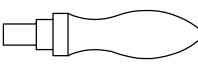
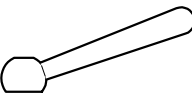
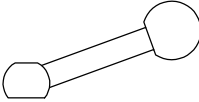
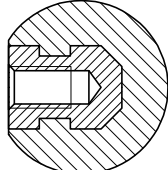

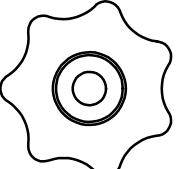
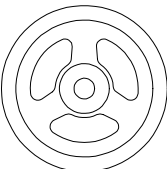
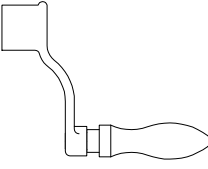
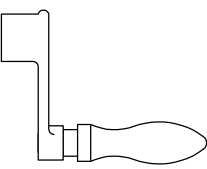
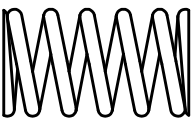
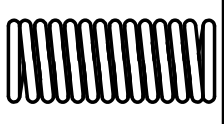



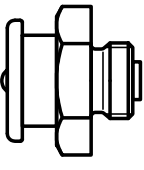
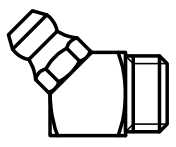
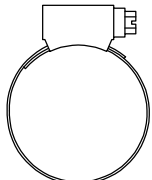
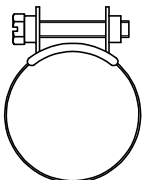
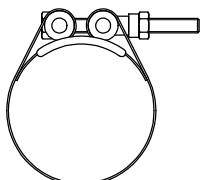
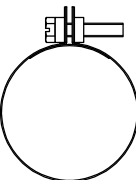
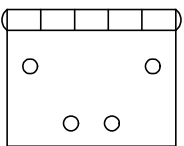
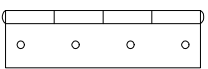

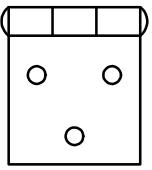
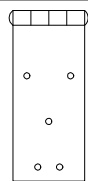
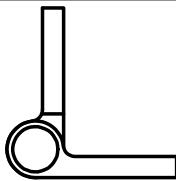
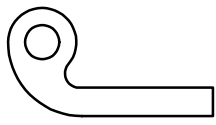

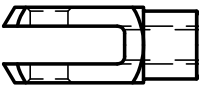
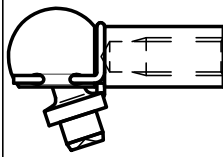
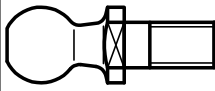
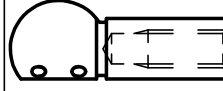
| | | | | | |
|---|---|---|---|---|---|
|  |  |  |  |  |  |
| DIN EN 1667 | DIN EN ISO 7040 | DIN EN ISO 7042 | DIN EN ISO 10511 | DIN EN ISO 10512 | DIN EN ISO 10513 |
|  |  |  |  |  |  |
| DIN 935-1 | DIN 935-3 | DIN 979 | DIN 70617 | DIN 70618 | DIN 546 |
|  |  |  |  |  |  |
| DIN 547 | DIN 548 | DIN 981 | DIN 1804 | DIN 1816 | DIN 8839 |
|  |  |  |  |  |  |
| DIN 58330 | DIN 64032 | DIN 70852 | DIN 82013 | DIN 466 | DIN 467 |
|  |  |  | |  |  |
| DIN 6303 | DIN 58521 | DIN 74361-3 | | DIN 582 | DIN 315 |
|  |  |  |  |  |  |
| DIN 7965 | DIN 8140-1 | DIN 16903-1 | DIN 16903-2 | DIN 16903-3 | DIN 16903-4 |
|  |  |  | | | |
| DIN 928 | DIN 929 | DIN 987 | | | |
|  |  |  |  |  |  |
| DIN 258 | DIN 1469 | DIN 5525 | DIN 5526 | DIN 7341 | DIN 8273-1 |
|  |  |  |  |  |  |
| DIN 8273-2 | DIN 20633 | DIN 43119-1 | DIN 43119-2 | DIN 43161 | DIN 48073 |

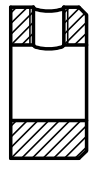
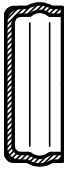
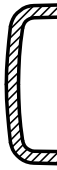

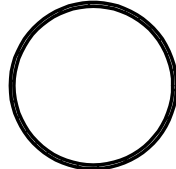
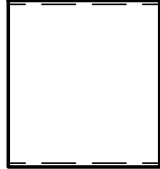
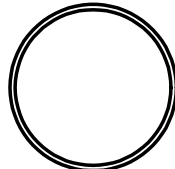
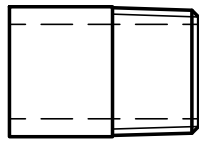
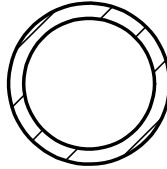
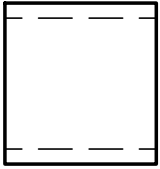
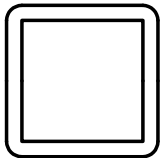
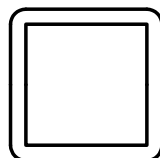
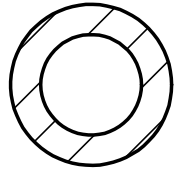
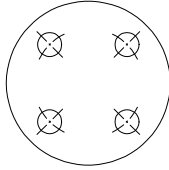
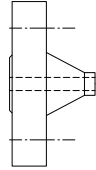
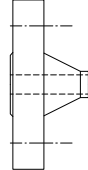
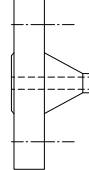
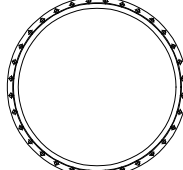
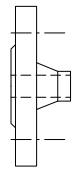
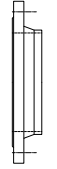
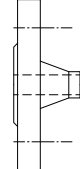

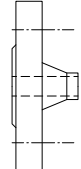
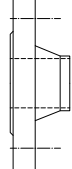
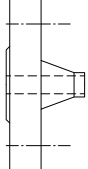
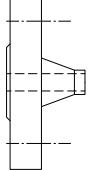
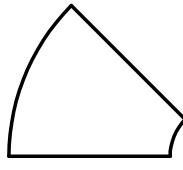
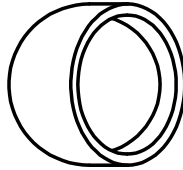
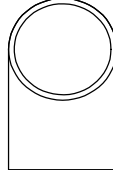
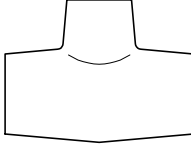
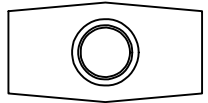
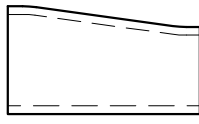
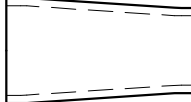
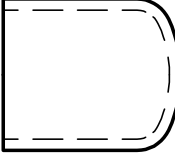

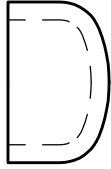
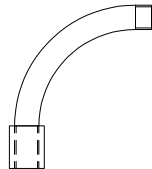
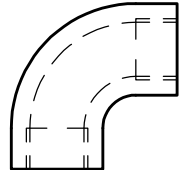
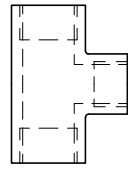
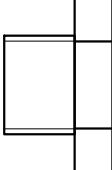
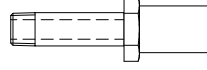

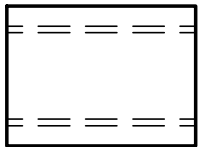

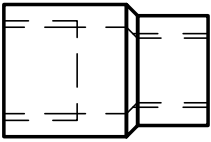
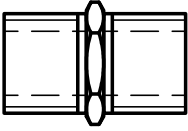
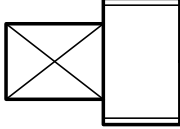
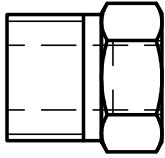
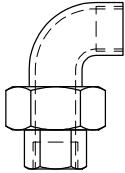

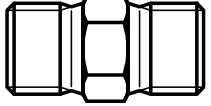
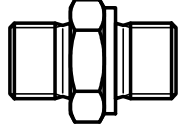
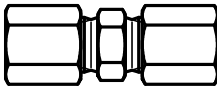
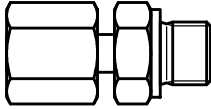
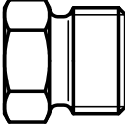
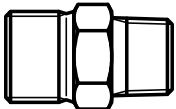
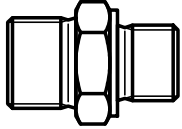
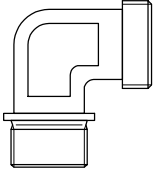
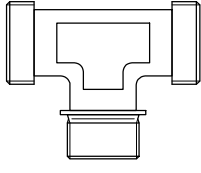
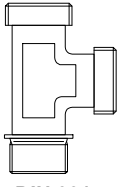
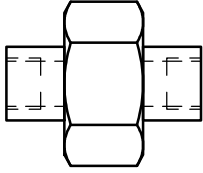
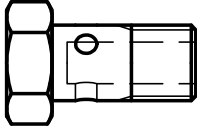
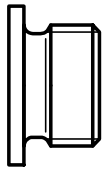
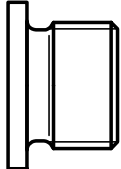
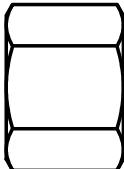
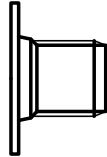
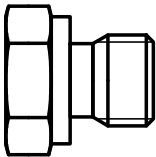
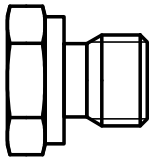
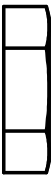
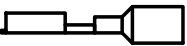
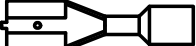











| | | | | | |
|---|---|---|--|---|---|
|  |  |  |  |  |  |
| DIN 82101 | DIN EN 22339 | DIN EN 22340 | DIN EN 22341 | DIN EN 28736 | DIN EN 28737 |
|  |  |  |  |  |  |
| DIN EN ISO 2338 | DIN EN ISO 8733 | DIN EN ISO 8734 | DIN EN ISO 8735 | DIN EN ISO 8739 | DIN EN ISO 8740 |
|  |  |  |  |  |  |
| DIN EN ISO 8741 | DIN EN ISO 8742 | DIN EN ISO 8744 | DIN EN ISO 8745 | DIN EN ISO 8746 | DIN EN ISO 8747 |
|  |  |  |  |  |  |
| DIN EN ISO 8748 | DIN EN ISO 8750 | DIN EN ISO 8752 | DIN EN ISO 9312 | DIN EN ISO 13337 | DIN EN ISO 13918 |
|  |  |  |  |  |  |
| DIN 1445 | DIN 42801 | DIN 58460 | DIN 58461 | DIN 58462 | DIN 58463 |
|  |  |  |  |  | |
| DIN 58464 | DIN 58469 | DIN 58470 | DIN 58471 | DIN 58472 | |
|  |  |  |  |  |  |
| DIN 124 | DIN 302 | DIN 660 | DIN 661 | DIN 662 | DIN 674 |
|  |  |  |  |  |  |
| DIN 6791 | DIN 6792 | DIN 7337 | DIN 7338 | DIN 7339 | DIN 7340 |
|  |  |  |  |  |  |
| DIN 11024 | DIN EN ISO 1234 | DIN 268 | DIN 271 | DIN 6881 | DIN 6883 |

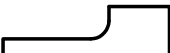







| | | | | | |
|---|---|---|---|---|---|
|  |  |  |  |  |  |
| DIN 6884 | DIN 6885-1 | DIN 6885-2 | DIN 6885-3 | DIN 6886 | DIN 6887 |
|  |  | | | | |
| DIN 6888 | DIN 6889 | | | | |
|  |  |  |  |  |  |
| DIN 125-1 | DIN 125-2 | DIN 126 | DIN 433-1 | DIN 433-2 | DIN 436 |
|  |  |  |  |  |  |
| DIN 440 | DIN 988 | DIN 1441 | DIN 6319 | DIN 6340 | DIN 6372 |
|  |  |  |  |  |  |
| DIN 6916 | DIN 7349 | DIN 7989 | DIN 9021 | DIN EN 28738 | DIN EN ISO 10669 |
|  |  |  |  |  | |
| DIN EN ISO 10673 | DIN 434 | DIN 435 | DIN 6917 | DIN 6918 | |
|  |  |  |  |  |  |
| DIN 128 | DIN 137 | DIN 6796 | DIN 6797 | DIN 6798 | DIN 6904 |
|  |  |  |  | | |
| DIN 6905 | DIN 6907 | DIN 6908 | DIN 7967 | | |
|  |  |  |  |  |  |
| DIN 93 | DIN 432 | DIN 462 | DIN 463 | DIN 5406 | DIN 70952 |

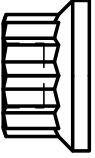
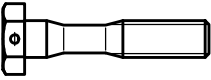
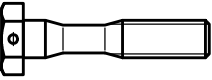
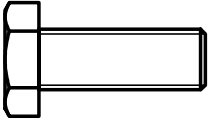

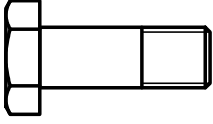
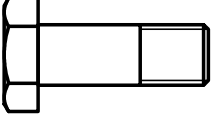

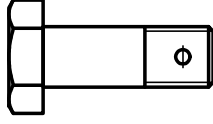
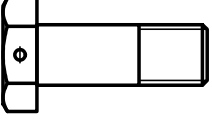
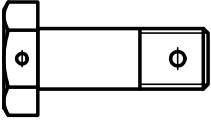
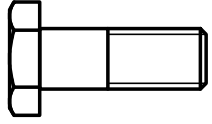
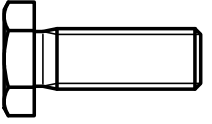
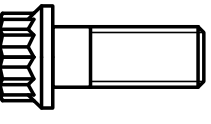
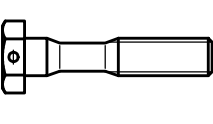
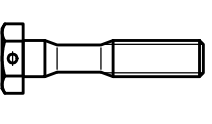
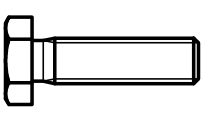
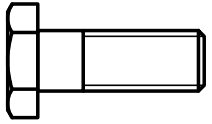
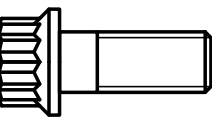
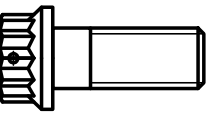
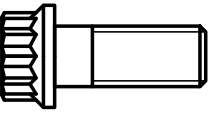
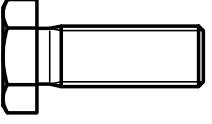
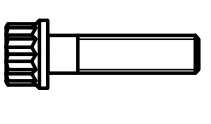
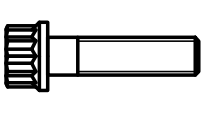
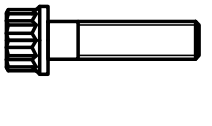
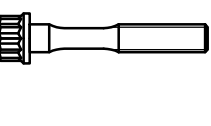
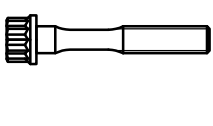
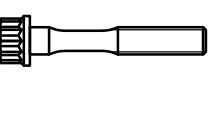
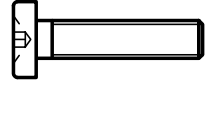
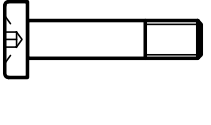

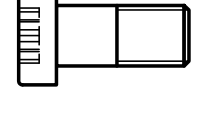
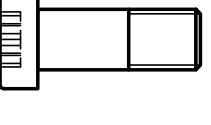
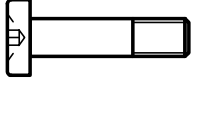
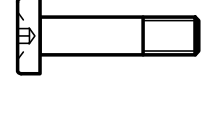
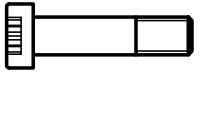
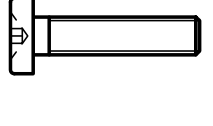
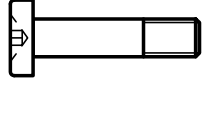
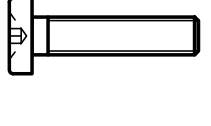
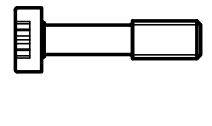
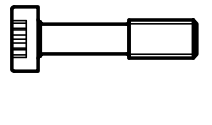
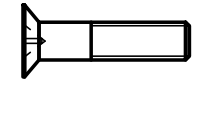
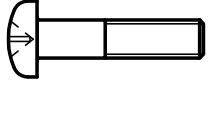
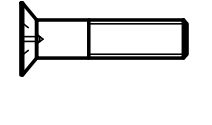
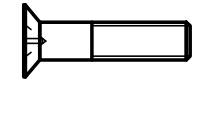
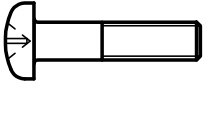
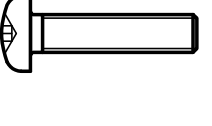

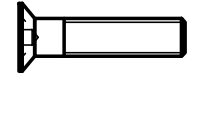
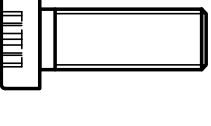
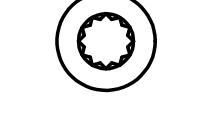
| | | | | | |
|---|---|--|---|---|---|
|  DIN 471 |  DIN 472 |  DIN 983 |  DIN 984 |  DIN 5417 |  DIN 6799 |
|  DIN 7993 |  DIN 73130 | |  DIN 158-1 |  DIN 2510-2 |  DIN 2510-8 |
|  DIN 7998 |  DIN 40430 |  DIN ISO 261 |  DIN ISO 228-1 |  DIN 76-1 |  DIN 78 |
|  DIN 66 |  DIN 74-1 |  DIN 974-1 |  DIN 974-2 |  DIN EN 20273 | |
|  DIN 332-1 |  DIN 332-2 |  DIN 332-4 |  DIN 332-8 |  DIN 509 |  DIN 649 |
|  DIN 615 |  DIN 617 |  DIN 618-1 |  DIN 618-2 |  DIN 625-1 |  DIN 625-3 |
|  DIN 625-4 |  DIN 626-1 |  DIN 626-2 |  DIN 628-1 |  DIN 628-3 |  DIN 628-4 |
|  DIN 630 |  DIN 635-1 |  DIN 635-2 |  DIN 720 |  DIN 5405-1 |  DIN 5412-1 |
|  DIN 5412-4 |  DIN 5412-9 |  DIN ISO 355 | | | |

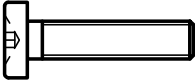
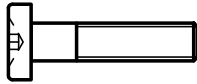
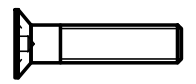
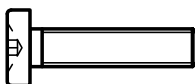
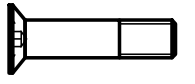
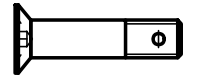

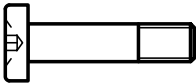
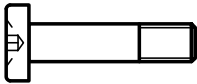

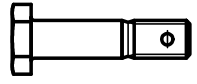
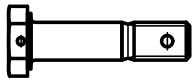
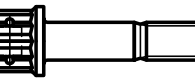
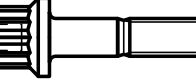
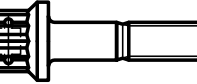

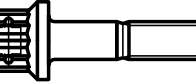
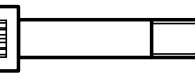
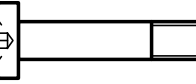
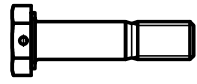
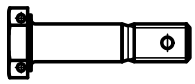
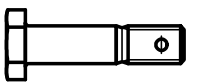
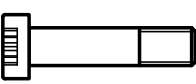
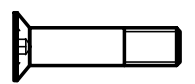
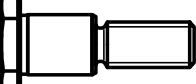
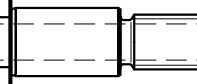
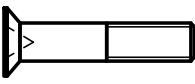
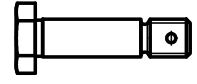
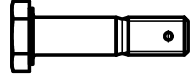
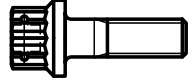
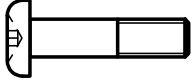
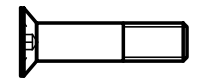
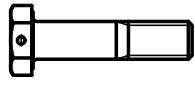
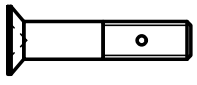
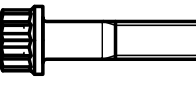

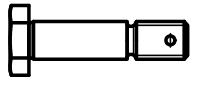
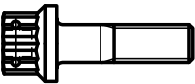
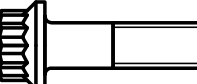
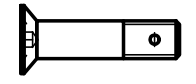
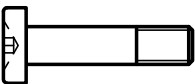
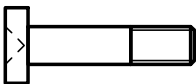
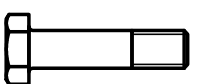
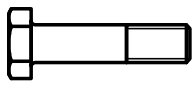
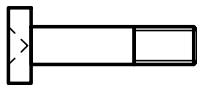
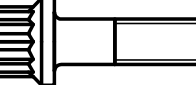
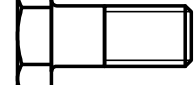
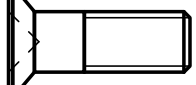
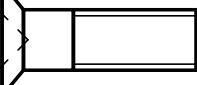

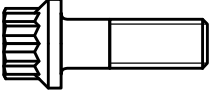
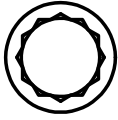
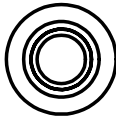
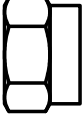
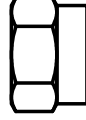

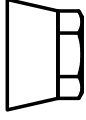



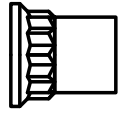

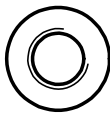
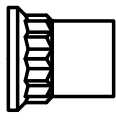

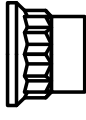







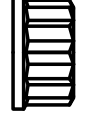
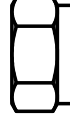

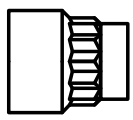

| | | | | | |
|---|---|---|---|---|---|
|  |  |  |  |  |  |
| DIN 711 | DIN 715 | DIN 722 | DIN 728 | DIN 5405-2 | DIN 5405-3 |
|  |  | | | | |
| DIN 5429-1 | DIN 5429-2 | | | | |
|  |  |  |  |  |  |
| DIN 736 | DIN 737 | DIN 738 | DIN 739 | DIN 5415 | DIN 5419 |
|  |  |  |  |  |  |
| DIN 1850-3 | DIN 1850-4 | DIN 1850-5 | DIN 1850-6 | DIN ISO 4379 | DIN 1494-1 |
|  |  |  |  |  |  |
| DIN 39 | DIN 98 | DIN 99 | DIN 6337 | DIN 319 | DIN 6335 |
|  |  |  |  |  |  |
| DIN 6336 | DIN 950 | DIN 468 | DIN 469 | DIN 2098-1 | DIN 2098-2 |
|  |  |  |  |  |  |
| DIN 2093 | DIN 3771-1 | DIN 7603 | DIN 3760 | DIN 3404 | DIN 71412 |
|  |  |  |  | |  |
| DIN 3017-1 | DIN 3017-2 | DIN 3017-3 | DIN 3017-5 | | DIN 7954 |
|  |  |  |  |  |  |
| DIN 7955 | DIN 7956 | DIN 7957 | DIN 7958 | DIN 31211 | DIN 31212 |

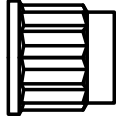
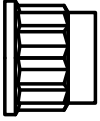
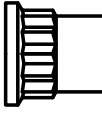

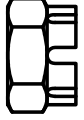



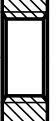

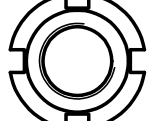



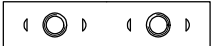

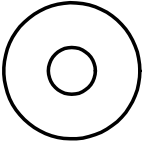
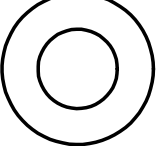

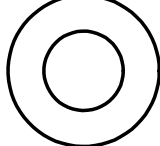

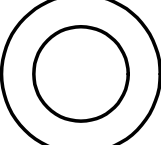

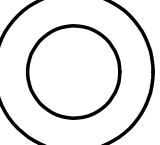

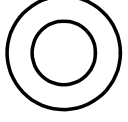
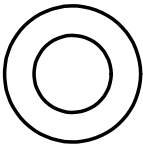
| | | | | | |
|---|---|---|--|---|---|
|  |  |  |  | |  |
| DIN 71752 | DIN 71802 | DIN 71803 | DIN 71805 | | DIN 15058 |
|  | |  |  |  | |
| DIN 705 | | DIN 442 | DIN 443 | DIN 470 | |
|  |  |  |  |  |  |
| DIN 2391-1 | DIN 2393-1 | DIN 2394-1 | DIN 2440 | DIN 2448 | DIN 2458 |
|  |  |  | | | |
| DIN EN 10210-2 | DIN EN 10219-2 | DIN EN ISO 1127 | | | |
|  |  |  |  |  |  |
| DIN 2527 | DIN 2627 | DIN 2628 | DIN 2629 | DIN 2630 | DIN 2631 |
|  |  |  |  |  |  |
| DIN 2632 | DIN 2633 | DIN 2634 | DIN 2635 | DIN 2636 | DIN 2637 |
|  |  |  |  |  |  |
| DIN 2638 | DIN 2605-1 | DIN 2605-2 | DIN 2607 | DIN 2615-1 | DIN 2615-2 |
|  |  |  |  |  |  |
| DIN 2616-1 | DIN 2616-2 | DIN 2617 | DIN 28011 | DIN 28013 | DIN 2983 |
|  |  |  |  |  |  |
| DIN 2987-1 | DIN 2987-2 | DIN 1565 | DIN 2981 | DIN 2982 | DIN 2986 |

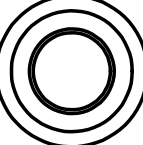

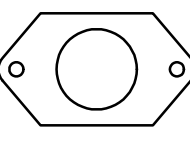

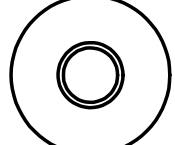

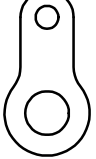
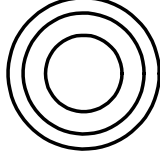
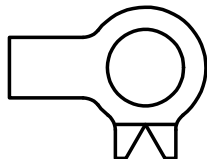
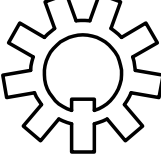
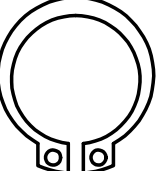
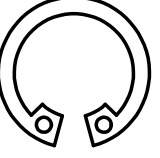
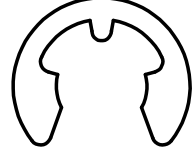
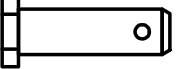
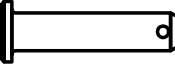
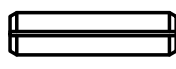
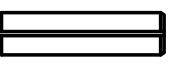
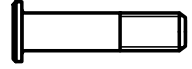
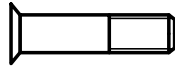

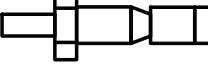
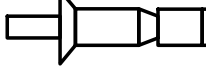
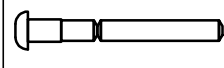
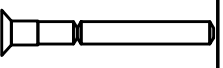
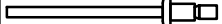
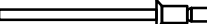
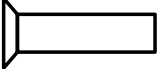
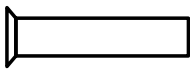
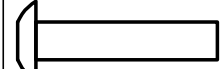
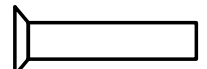

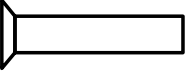
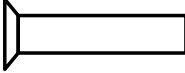
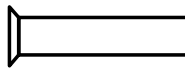
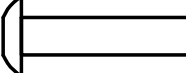

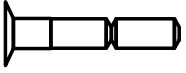
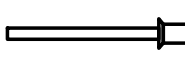
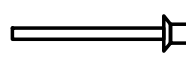
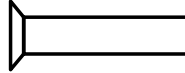
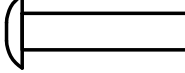
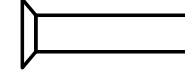
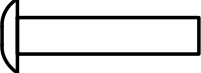
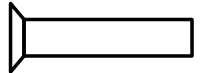
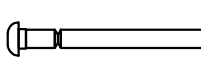
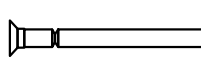
| | | | | | |
|---|---|---|---|---|---|
|  |  |  |  |  |  |
| DIN 2988 | DIN 2990 | DIN 2991 | DIN EN 10241 | DIN EN 10242 | DIN 2353 |
|  |  |  |  |  |  |
| DIN 7631 | DIN 7632 | DIN EN ISO 8434-1 | DIN 3955 | DIN 7633 | DIN 3900 |
|  |  |  |  |  |  |
| DIN 3901 | DIN 3904 | DIN 3907 | DIN 3914 | DIN 2993 | DIN 4643 |
|  |  |  |  |  |  |
| DIN 3852-1 | DIN 3852-2 | DIN 3870 | DIN ISO 6149-1 | DIN ISO 6149-2 | DIN ISO 6149-3 |
|  | | | | | |
| DIN EN ISO 8434-1 | | | | | |
|  |  |  |  |  |  |
| DIN 46245-1 | DIN 46245-2 | DIN 46245-3 | DIN 46247-1 | DIN 46247-2 | DIN 46247-3 |
|  |  |  |  |  |  |
| DIN 46247-4 | DIN 46330-1 | DIN 46330-2 | DIN 46228-1 | DIN 46228-2 | DIN 46228-3 |
|  |  |  |  |  |  |
| DIN 46228-4 | DIN 46341-1 | DIN 46211 | DIN 46225 | DIN 46230 | DIN 46231 |
|  |  |  |  |  |  |
| DIN 46234 | DIN 46235 | DIN 46237 | DIN 46342-1 | DIN 46343-1 | DIN 46343-2 |

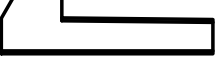
| | | | | | |
|--|---|---|---|---|---|
|  |  |  |  |  |  |
| DIN 65110 | DIN 65115 | DIN 65177 | DIN 65265 | DIN 65267 | DIN 65268 |
|  |  |  |  |  |  |
| DIN 65330 | DIN 65522 | DIN 65523 | DIN 65524 | DIN 65555 | LN 9037 |
|  |  |  |  |  |  |
| LN 9038 | LN 9081-1 | LN 9347 | LN 9350 | LN 9380 | LN 9386 |
|  |  |  |  |  |  |
| LN 29520 | LN 29550 | LN 29551 | LN 65027 | LN 65101 | LN 65102 |
|  |  |  |  | | |
| LN 65103 | LN 65104 | LN 65105 | LN 65106 | | |
|  |  |  |  |  |  |
| DIN 65313 | DIN 65318 | DIN 65502 | DIN 65515 | DIN 65516 | DIN 65518 |
|  |  |  |  |  |  |
| DIN 65519 | DIN 65537 | DIN 65541 | DIN 65554 | DIN 65557 | E DIN 65539 |
|  |  |  |  |  |  |
| E DIN 65540 | LN 9136 | LN 9139 | LN 9438 | LN 9441 | LN 9442 |
|  |  |  |  |  |  |
| LN 29785 | LN 29787 | LN 29794 | LN 29940 | LN 29949 | LN 29950 |

| | | | | | |
|---|---|---|--|---|---|
|  |  |  |  | | |
| LN 29958 | LN 65003 | LN 65019 | LN 65022 | | |
|  |  |  |  |  |  |
| DIN 65179 | DIN 65269 | DIN 65314 | DIN 65316 | DIN 65319 | DIN 65320 |
|  |  |  |  |  |  |
| DIN 65324 | DIN 65338 | DIN 65339 | DIN 65438 | DIN 65439 | DIN 65440 |
|  |  |  |  |  |  |
| DIN 65441 | DIN 65442 | DIN 65443 | DIN 65517 | DIN 65520 | DIN 65525 |
|  |  |  |  |  |  |
| DIN 65526 | DIN 65527 | DIN 65538 | DIN 65542 | LN 9082 | LN 9083 |
|  |  |  |  |  |  |
| LN 9469 | LN 9485 | LN 29522 | LN 29769 | LN 29781 | LN 29784 |
|  |  |  |  |  |  |
| LN 29792 | LN 29892 | LN 29901 | LN 29902 | LN 29903 | LN 29930 |
|  |  |  |  |  |  |
| LN 29934 | LN 29955 | LN 29956 | LN 29957 | LN 65005 | LN 65028 |
|  |  |  |  |  |  |
| LN 65029 | LN 65044 | LN 65056 | LN 65401 | LN 65402 | LN 65403 |

| | | | | | |
|---|---|---|---|---|---|
|  |  |  | | | |
| LN 65416 | LN 65417 | LN 65418 | | | |
|  |  |  |  |  |  |
| DIN 65249 | DIN 65245 | DIN 65480 | DIN 65500 | DIN 65507 | DIN 65508 |
|  |  |  |  |  |  |
| DIN 65509 | DIN 65510 | DIN 65528 | DIN 65529 | DIN 65530 | DIN 65531 |
|  |  |  |  |  |  |
| DIN 65534 | DIN 65546 | E DIN 65545 | LN 9161 | LN 9338 | LN 9339 |
|  |  |  |  |  |  |
| LN 9342 | LN 9343 | LN 9348 | LN 9481 | LN 29529 | LN 29552 |
|  |  |  |  |  |  |
| LN 29630 | LN 29669 | LN 29790 | LN 29894 | LN 29919 | LN 29942 |
|  |  |  | | | |
| LN 29953 | LN 65057 | LN 65128 | | | |
|  |  |  |  |  | |
| DIN 65246 | DIN 65247 | LN 9345 | LN 9484 | LN 29931 | |
|  |  |  |  | | |
| LN 9486 | LN 9487 | LN 29959 | LN 29960 | | |

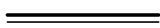
| | | | | | |
|---|---|---|--|---|---|
|  |  |  | | | |
| LN 29682 | LN 29993 | LN 65134 | | | |
|  |  |  |  |  |  |
| DIN 65209 | DIN 65465 | DIN EN 2122 | DIN EN 2138 | DIN EN 2139 | E DIN EN 3016 |
|  |  |  |  |  |  |
| E DIN EN 3267 | LN 9016 | LN 9025 | LN 9029 | LN 9166 | LN 9218 |
|  |  |  |  |  |  |
| LN 9482 | LN 9483 | LN 29905 | LN 29917 | LN 29932 | LN 29952 |
|  |  | |  |  |  |
| LN 65045 | LN 65049 | | DIN 65456 | LN 9022 | LN 9023 |
|  | |  |  |  | |
| LN 29961 | | LN 471 | LN 472 | LN 6799 | |
|  |  |  |  |  |  |
| DIN EN 2364 | LN 1434 | LN 1481 | LN 7346 | LN 29796 | LN 29797 |
|  |  |  |  |  |  |
| LN 29946 | LN 65664 | DIN 29921 | DIN 29924 | DIN 65155 | DIN 65156 |
|  |  |  |  |  |  |
| DIN 65158 | DIN 65159 | DIN 65258 | DIN 65259 | DIN 65260 | DIN 65379 |

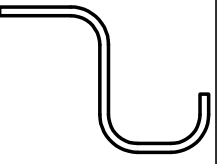
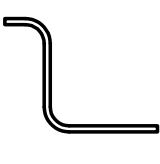
| | | | | | |
|--|---|---|---|---|---|
|  |  |  |  |  |  |
| DIN 65399 | DIN 65444 | DIN 65445 | DIN 65446 | DIN 65547 | DIN 65548 |
|  |  |  |  |  |  |
| DIN 65549 | DIN 65551 | DIN 65552 | E DIN 65479 | LN 9178 | LN 9179 |
|  |  |  |  | |  |
| LN 9198 | LN 9199 | LN 9311 | LN 9312 | | DIN EN 2367 |
|  |  | | | | |
| ISO 2491 | ISO 2492 | | | | |
|  |  |  |  |  |  |
| DIN ISO 5855-2 | LN 9163-2 | LN 9163-3 | LN 9163-4 | LN 9163-5 | LN 9163-6 |
|  | |  | | | |
| LN 9163-7 | | LN 9494-1 | | | |
|  |  | | | | |
| LN 9415 | LN 9416 | | | | |
| | | | | | |
| | | | | | |